

RoHS

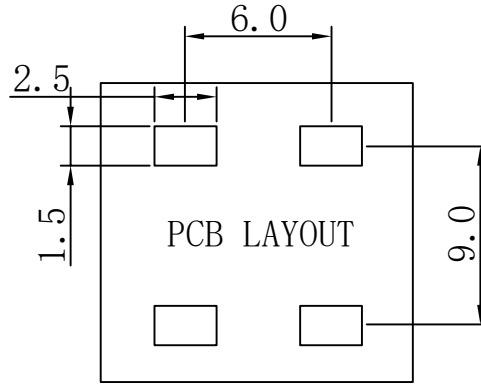

技术要求:

- 1.打铜底0.5-1 μ m,镍2-2.5 μ m, 镀雾锡3-5 μ m。
- 2.铆好后不得有松动现象。
- 3.插脚尖部符合可焊性要求。
- 4.螺纹需符合通止规/止针要求。
- 5.螺纹扭矩: 1.4Nm.
- 6.额定电流: 50A.

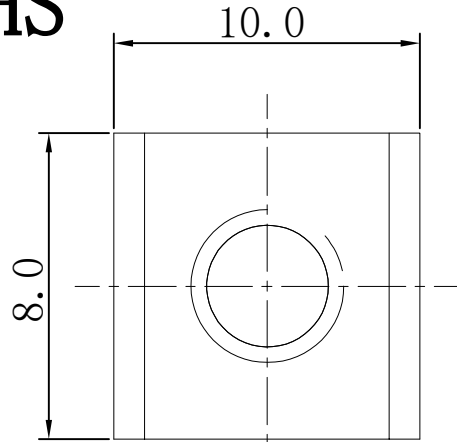
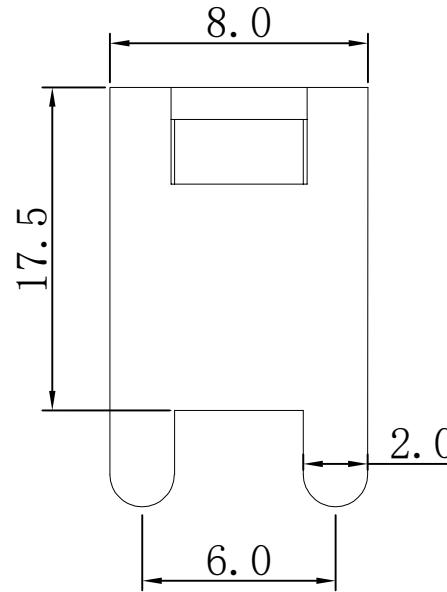
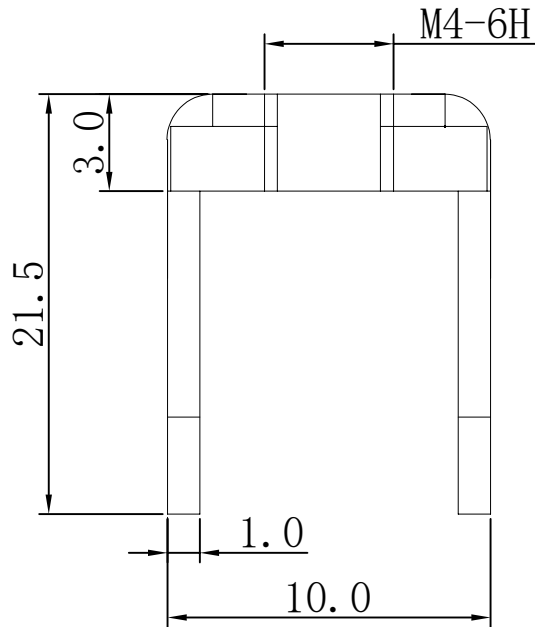

>30.±0.4	X.°±
6-30±0.3	.X°±
0-6±0.2	.XX°±
ANGLES±1°	.XXX°±
UNITS:	mm

PART NO:		TT44100080-2150		XFCN 兴飞连接器	
TITLE:		PCB SOLDERING TERMINAL		0769-82001899	
				www.xfconn.com	
				DWG NO: /	
APPD	Chen ZhiQiang	VIEW			
CHKD	Liu Wei	SCALE	SHEET	REV	
DRAW	Chen HongJiang	DATE	1/1	A1	
DATE	2024.04.23	NONE			

THESE DRAWINGS AND SPECIFICATIONS ARE THE PROPERTY OF XFCN AND SHALL NOT BE REPRODUCED, COPIED OR CUED IN ANY MANNER WITHOUT THE PRIOR WRITTEN CONSENT OF XFCN

2	垫片		SPCC	1
1	插脚		H62 (Y2)	1
序号	名称	零件编号	材质	数量