

RoHS

REV	ECN NO.	DESCRIPTION	DESIGN	APPROVAL	DATE
A1	NEW	更换图框			2023.11.25

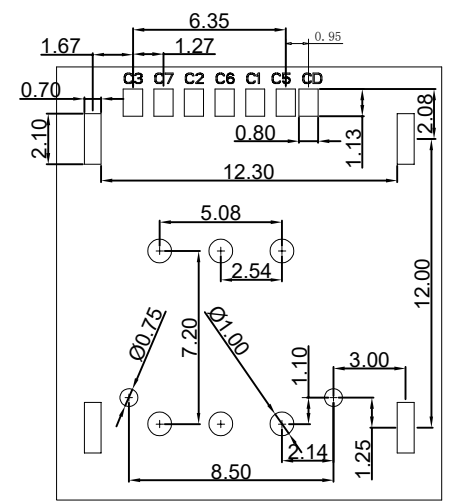

- NOTES:
- MATERIAL:
HOUSING:LCP S475 UL 94V-0
CONTACT:C5210R-H
SHELL:SUS304-H
 - FINISH:
CONTACT:GOLD FLASH PLATED ON CONTACT AREA
GOLD FLASH PLATED ON SOLDER TAILS
 - ELECTRICAL CHARACTERISTICS
RATING CURRENT : 0.5A MAX
CONTACT RESISTANCE :50 mΩ MAX
DIELECTRIC WITHSTANDING : 500V AC MIN
INSULATION RESISTANCE: 1000 MΩ MIN
 - MECHANICAL CHARACTERISTICS
MATING CYCLE :3000 CYCLES

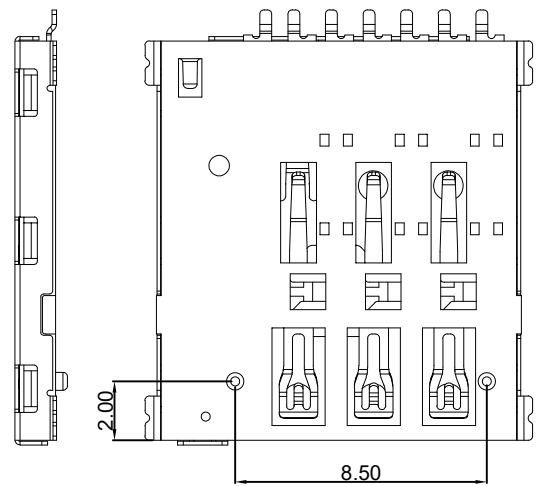
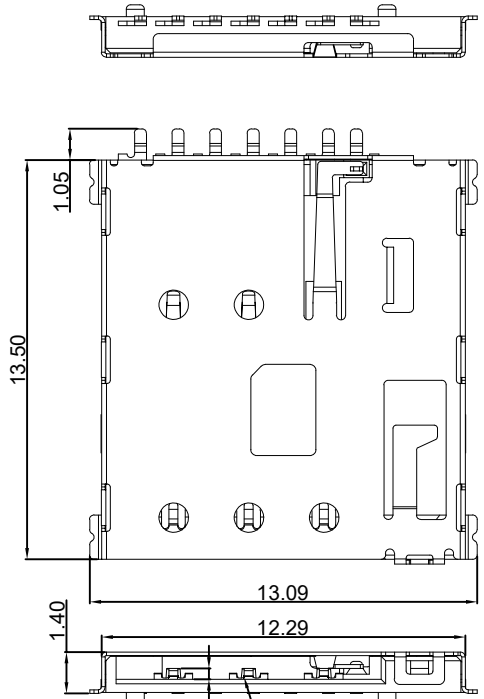
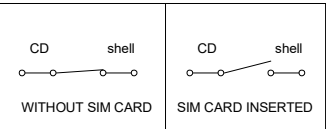
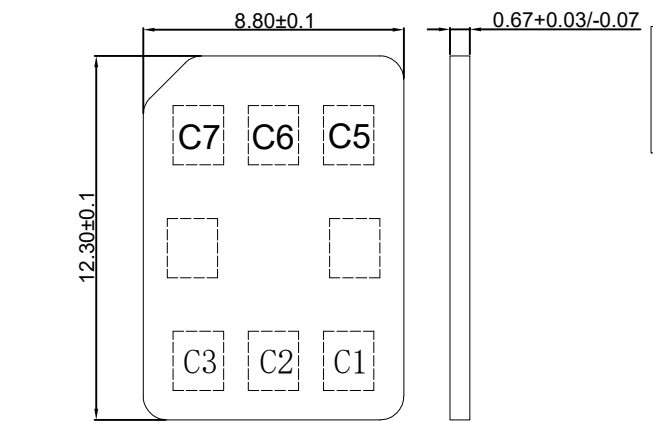

SIM pin Assignment	
PIN#	Name
C1	VCC
C2	RST
C3	CLK
C5	GND
C6	VPP
C7	I/O

X. 0. 3	X. ° ±
. X ± 0. 2	. X ° ±
. XX ± 0. 08	. XX ° ±
. XXX ± 0. 03	. XXX ° ±
UNITS:	mm

THESE DRAWINGS AND SPECIFICATIONS ARE THE PROPERTY OF XFCN AND SHALL NOT BE REPRODUCED, COPIED OR CUED IN ANY MANNER WITHOUT THE PRIOR WRITTEN CONSENT OF XFCN

PART NO: NOS11-S1F1-2000-A	
TITLE: NANO SIM PUSN 卡座	
APPD	Chen ZhiQiang
CHKD	Liu Wei
DRAW	Chen HongJiang
DATE	2024.08.19

XFCN 兴飞连接器	
0769-82001899	
www.xfconn.com	
DWG NO: /	
VIEW	
SCALE	SHEET
NONE	1/2
DATE	A1

RoHS

REV	ECN NO.	DESCRIPTION	DESIGN	APPROVAL	DATE
A1	NEW	更换图框			2023.11.25

QTY/REEL	REEL/CARTON	QTY/CARTON
1500	10	15000

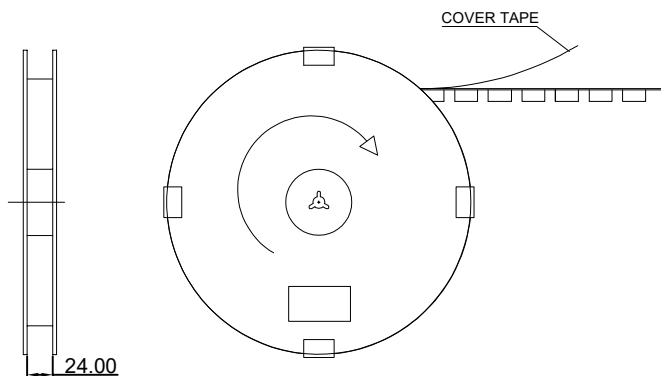
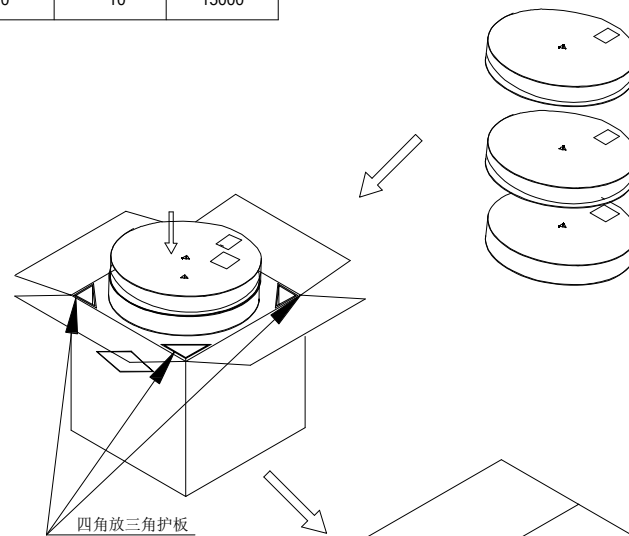
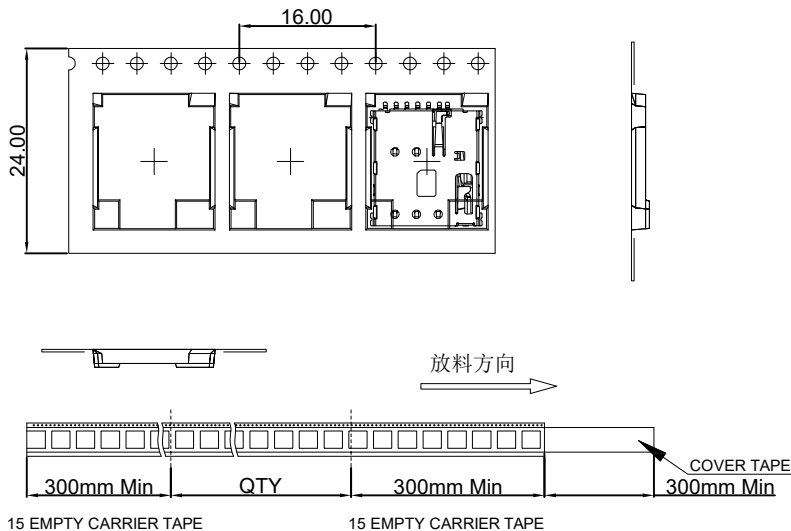

1. 每盘前后空5PCS 中间包装1500PCS
2. 每箱10盘, 共15000PCS.
3. 纸箱四角放脚柱。

X. 0.3	X.°±	PART NO: NOS11-S1F1-2000-A	XFCN 兴飞连接器		
. X±0.2	.X°±				
. XX±0.08	.XX°±		DWG NO: /		
. XXX±0.03	.XXX°±				
UNITS:	mm	VIEW:			
THESE DRAWINGS AND SPECIFICATIONS ARE THE PROPERTY OF XFCN AND SHALL NOT BE REPRODUCED, COPIED OR CUED IN ANY MANNER WITHOUT THE PRIOR WRITTEN CONSENT OF XFCN		0769-82001899 www.xfconn.com			SCALE: NONE
		SHEET: 2/2			REV: A1